

INSTALLATION INSTRUCTIONS

Part # 23-1002 for Setrab 1-series coolers

Part # 23-6002 for Setrab 6-series coolers

Part # 23-9002 for Setrab 9-series coolers

Read these instructions completely before beginning installation or service.

KIT CONTENTS

QTY.	DESCRIPTION
2	Aluminum mounting brackets with rubber damping pads
4	Steel back plates with rubber damping pads, threaded M6-1
8	M6-1x14 steel button cap screws

TOOLS SUGGESTED

5/32" or 4mm hex key tool

CAUTION!

To prevent injury, allow vehicle to cool before attempting installation and/or disassembly and cleaning.

INSTALLATION

- Place mounting bracket on top of oil cooler with damping pads facing cooler top plate.
NOTE: If your oil cooler has a thick Setrab blister logo decal affixed to the top or bottom pleate please remove this thick decal to ensure the best mounting bracket fitment and performance.
- Place steel back plates under each oil cooler mounting tab with rubber damping pads toward mounting bracket.
- Use included M6-1x14 steel button cap screws to fasten.
NOTE: Application of a medium-strength thread-locking compound is recommended for a more secure screw installation.
- Snugly tighten screws, taking care not to distort or damage rubber damping pads.
- Repeat steps 1–4 to install bottom bracket.

ATTENTION: These brackets are to assist in the mounting and protection of the oil cooler; however, mounting an oil cooler with these brackets is no guarantee of protection or substitute for common sense. Ensure that oil lines have been secured as closely as possible to their entry of, and exit from, the oil cooler. Every attempt should be made to secure the mounting hardware to a mounting location that will isolate the cooler from chassis flex.

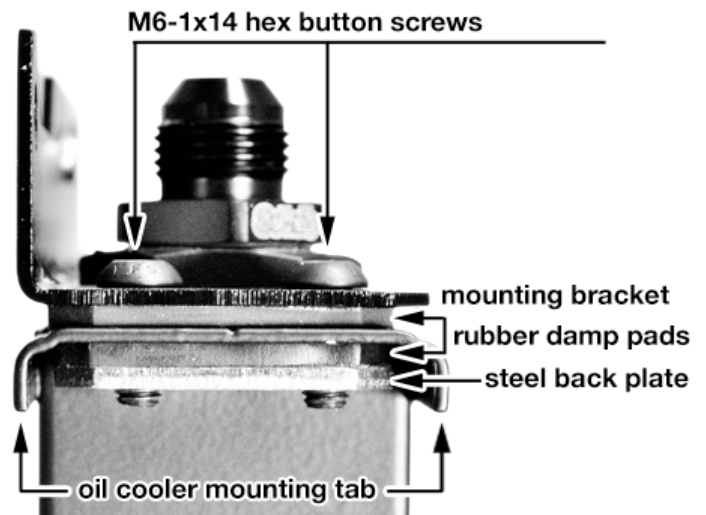

ACCESSORIES AVAILABLE

PART #	DESCRIPTION
TL T-HAND 5/32	Looped T-handle Hex Key Tool
11-RU69-20 11-RU69-34	sūsa HyperFlow Engine Oil Filters are designed for maximum filtration and maximum flow. Filtering to 30 microns, flowing 8-12x greater than traditional media filters, and employing an exceptionally-strong rare-earth magnet for additional ferrous collection, this engine oil filter is unsurpassed.
31-TS180-__*	sūsa Thermal Switch, 180°F, *-06, -08, -10, or -12
31-TS190-__*	sūsa Thermal Switch, 190°F, *-06, -08, -10, or -12

For the entire range of adapter fittings, hose ends, and many other accessories, visit:

www.setrabusa.com



23-6002
sūsa ProLine STD6 Mount Kit
Mfr. P/N: 23-6002